

SHARP

Be Original.

AR-6031NV
AR-6026NV
AR-6023NV
AR-6020NV

Digital Multifunction System

A Network-Ready 3-in-1 Document Solution Built to Boost Your Business



Enhance Workflow with Quality and Versatility

The compact yet robust AR-6031NV/6026NV/6023NV/6020NV offers sophisticated features to match the changing productivity needs of small workgroups. Whether it's a copy, print, or scan job, document functionality comes with consistently excellent quality. Everyone on your team will appreciate a streamlined workflow and boosted productivity. With one of these affordable MFPs, you have a versatile all-in-one document solution.

DOCUMENT WORKFLOW

Convenient Full-Colour Network Scanning

The AR-6031NV/6026NV/6023NV/6020NV excels as a full-colour network scanner. Quickly convert any type of paper-based document into a TIFF, PDF, or JPEG and send it to one of six pre-registered destinations. Scanned files can be sent as e-mail attachments, sent directly to a PC desktop*¹, or scanned directly to an FTP server, USB drive, or mobile device*². It's all so easy—just tap the Scan Mode button, select a pre-registered destination, and press Start.

Example of Assigning Buttons

Button 1-3

Scan to E-mail A/B/C

Scanned files can be sent as an attachment to any e-mail address over the Internet.

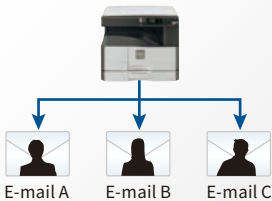

Button 4

Scan to FTP Server

Scanned files can be stored on a file server where they can be easily accessed from any PC on the network.

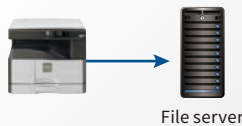

Button 5

Scan to USB Drive

Scanned files can be stored directly on a USB drive.



Button 6

Scan to Desktop*¹ or Mobile Device*²

Scanned files can be forwarded directly to your PC or a mobile device.

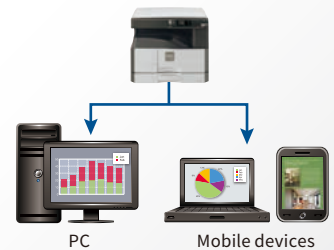

Note: Buttons 1-6 must be assigned a scan destination in advance. Scan to Desktop and Scan to Mobile Device can be assigned to Button 6 only. Choose which one you would like to assign.

*1: Requires optional Sharpdesk License Kit. Sharpdesk must be installed on PC. *2: Mobile device must have Sharpdesk Mobile app installed.

3-in-1 PERFORMANCE

Super-Efficient Output

The AR-6031NV/6026NV/6023NV/6020NV delivers a fast output of 31/26/23/20 ppm*. The first copy comes out in just 5.2/5.2/6.4/6.4 seconds for A4 and 5.2/5.2/6.5/6.5 seconds for 8 1/2" x 11", saving valuable time when you're doing multiple short-run jobs.

*A4 (8 1/2" x 11"), long-edge feeding

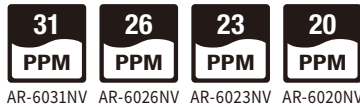

Automatic Document Feeding

An optional RSPF (reversing single pass feeder) efficiently feeds in up to 100 sheets of either one- or two-sided originals.



Built-in Stackless Duplex Module

The AR-6031NV/6026NV/6023NV/6020NV can make two-sided printouts using its built-in stackless duplex module. This effectively reduces paper costs and saves filing space. Duplex copying is even more effective when used together with the optional RSPF.



Effective Paper Handling

For large-volume jobs and a wider selection of available paper sizes, these MFPs can accommodate two types of extra trays that increase total paper capacity to 2,100 sheets (AR-6031NV/6026NV) or 1,850 sheets (AR-6023NV/6020NV). These MFPs can accommodate heavy paper up to 200 g/m²*, expanding the range of possible printing applications.



*106–200 g/m² paper to be fed through multi-bypass tray.

Network Printing

These MFPs come standard-equipped with network printing, making them ideal for use by small workgroups. They also incorporate Sharp's original SPLC (Sharp Printer Language with Compression) PDL, which can be upgraded to PCL 6 and PostScript® 3™ emulation to enhance graphics and font capabilities.

Note: PCL requires optional AR-PB10. PostScript 3 requires optional AR-PB10 and MX-PK10.

Printing via USB Cable

If you can't connect to your office network, you can connect the MFP to your PC via a USB cable and print documents. This allows you to print safely without sending your data through the office network. The USB port can be used even while the MFP is connected to the network.

ID Card Copy

The AR-6031NV/6026NV/6023NV/6020NV has a dedicated key for easy copying of both sides of a card (e.g., an ID or credit card) onto a single page.

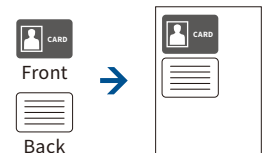

Rotation Sort*

Every other copy is rotated 90 degrees when delivered to the output tray. This takes the hassle out of sorting copies and comes in handy when you need to print multiple copies.

*Two paper trays must be loaded with the same-sized paper in a different orientation (landscape and portrait).



Other Convenient Features

- 2-in-1/4-in-1 copying
- Margin shift
- Edge/centre erase

OTHER KEY FEATURES

Sharpdesk Mobile*

Sharpdesk Mobile is a mobile print/scan application. With Sharpdesk Mobile, users can import documents scanned on the AR-6031NV/6026NV/6023NV/6020NV to their mobile devices for previewing and saving. And files on a mobile device can be printed out on the MFP, sent as e-mail attachments, or used in other applications.



*Requires commercially available wireless LAN router; printing requires optional AR-PB10. PDF printing additionally requires optional MX-PK10. Availability varies by country/region. For details, see the support website: http://sharp-world.com/products/copier/docu_solutions/mobile/sharpdesk_mobile/

Sharpdesk*

With Sharpdesk integrated document management software, scanned files can be organised, edited, converted, and combined with ease. What's more, Full Text Search makes it easy to retrieve your documents.

*Requires optional Sharpdesk License Kit.

Energy Efficiency

- Pressing the power save key after a job is finished immediately puts the MFP into auto power shut-off mode, further reducing your running costs.
- Certified under the ENERGY STAR® programme (an international system for rating the energy efficiency of products).



SPECIFICATIONS (tentative)

General

Type	Desktop
Engine speed	A4 (8 1/2" x 11")*1: Max. 31/26/23/20 ppm A3 (11" x 17")*: Max. 17/15/12 (11)/11 (10) ppm
Control panel display	Custom LCD
Paper size	Max. A3 (11" x 17"), min. A6*2 (5 1/2" x 8 1/2")
Paper capacity (80 g/m ²)	[AR-6031NV/6026NV] Standard: 1,100 sheets (500-sheet tray x 2 and 100-sheet multi-bypass tray) Maximum: 2,100 sheets (1,100 sheets & optional 500-sheet tray x 2) [AR-6023NV/6020NV] Standard: 350 sheets (250-sheet tray and 100-sheet multi-bypass tray) Maximum: 1,850 sheets (350 sheets & optional 500-sheet tray x 3)
Paper weight	Tray: 55 g/m ² to 105 g/m ² (13 lbs bond to 28 lbs bond) Multi-bypass tray: 55 g/m ² to 200 g/m ² (13 lbs bond to 110 lbs index)
Warm-up time*3	AR-6031NV/6026NV: 20 sec. AR-6023NV/6020NV: 25 sec.
Memory	Standard: 320 MB Maximum: 448 MB
Power requirements	Rated local AC voltage ±10%, 50/60 Hz
Power consumption	AR-6031NV/6026NV: Max. 1.45 kW AR-6023NV/6020NV: Max. 1.2 kW
Dimensions (W x D x H)*4	AR-6031NV/6026NV: 599 x 612 x 611 mm (23 19/32" x 24 7/64" x 24 1/16") AR-6023NV/6020NV: 599 x 612 x 511 mm (23 19/32" x 24 7/64" x 20 1/8")
Weight (approx.)*4	AR-6031NV/6026NV: 37 kg (81.6 lbs) AR-6023NV/6020NV: 29 kg (64.0 lbs)

Copier

Original paper size	Max. A3 (11" x 17")
First copy time*5	[AR-6031NV/6026NV] 5.2 seconds [AR-6023NV/6020NV] A4: 6.4 seconds 8 1/2" x 11": 6.5 seconds
Continuous copy	Max. 999 copies
Resolution	600 x 600 dpi
Gradation	256 levels
Zoom range	25% to 400% (50% to 200% using RSPF) in 1% increments
Pre-set copy ratios*6	Metric: 10 ratios (5R/5E), inch: 10 ratios (5R/5E)

Network Printer

Resolution	600 x 600 dpi
Interface	USB 2.0, 10Base-T/100Base-TX
Supported OS*7	Windows Server® 2008, Windows Server® 2008 R2, Windows Server® 2012, Windows Server® 2012 R2, Windows Server® 2016, Windows Vista®, Windows® 7, Windows® 8.1, Windows® 10, Mac OS 10.6, 10.7, 10.8, 10.9, 10.10, 10.11, 10.12
Network protocols	TCP/IP
PDL	Standard: SPLC (Sharp Printer Language with Compression) Option*8: PCL 6 emulation, PostScript® 3™ emulation
Available fonts	80 fonts for PCL, 136 fonts for PostScript 3 emulation

Network Colour Scanner

Scan method	Push scan (via control panel) Pull scan (TWAIN-compliant application)
Resolution	Push scan: 75, 100, 150, 200, 300, 400, 600 dpi Pull scan: 75, 100, 150, 200, 300, 400, 600 dpi; 50 dpi to 9,600 dpi via user setting*9
File formats	TIFF, PDF, JPEG*10
Scanner utility	Sharpdesk*11
Scan destinations	Scan to e-mail/desktop*11/FTP server/USB drive

- *1: Long-edge feeding.
- *2: Short-edge feeding only.
- *3: At rated voltage, 23°C (73.4°F). May vary depending on operating conditions and environment.
- *4: Including document cover and adjuster.
- *5: Long-edge feeding of A4 (8 1/2" x 11") sheets from 1st paper tray. May vary depending on operating conditions and environment.
- *6: Pre-set copy ratios of 25% and 400% cannot be used with RSPF.
- *7: Windows Server requires optional AR-PB10. Mac OS requires optional AR-PB10 and MX-PK10.
- *8: PCL requires optional AR-PB10. PostScript 3 requires optional AR-PB10 and MX-PK10.
- *9: Resolution will vary depending on the size of the scanned area.
- *10: Colour/greyscale only.
- *11: Requires optional Sharpdesk License Kit.

- Design and specifications are subject to change without prior notice.
- PCL is a registered trademark of Hewlett-Packard Company. PostScript 3 is either a registered trademark or trademark of Adobe Systems Incorporated in the US and/or other countries. Windows, Windows Server, and Windows Vista are registered trademarks of Microsoft Corporation in the US and/or other countries. Mac is a trademark of Apple Inc., registered in the US and other countries. All other brand names and product names may be trademarks or registered trademarks of their respective owners.
- The ENERGY STAR logo is a certification mark and may only be used to certify products that have been determined to meet the ENERGY STAR programme requirements. ENERGY STAR and the ENERGY STAR mark are registered trademarks owned by the US Environmental Protection Agency. The ENERGY STAR guidelines apply to products only in the US, the EU, Japan, Canada, Australia, New Zealand, and Taiwan.

SYSTEM CONFIGURATION

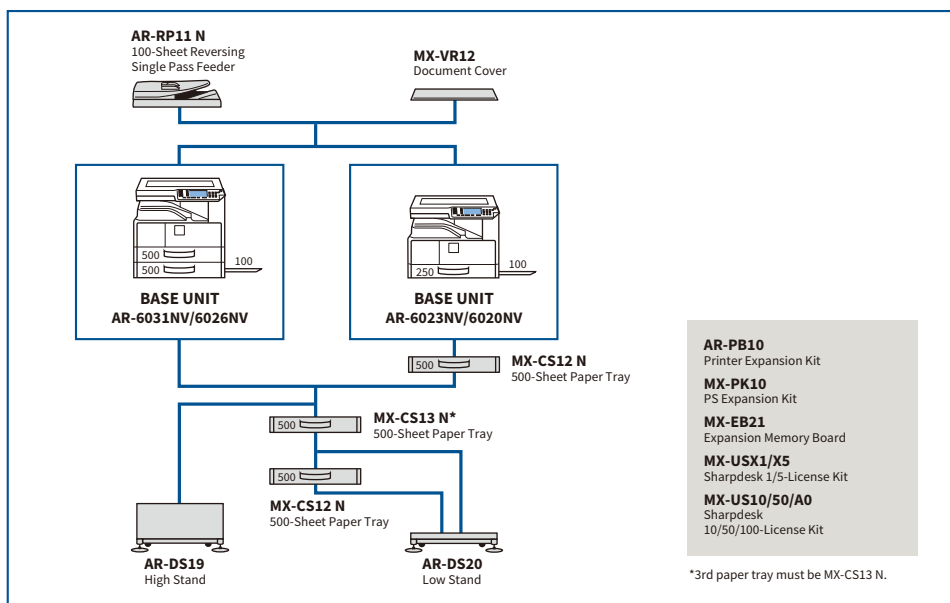

Certain options may not be available in some areas.

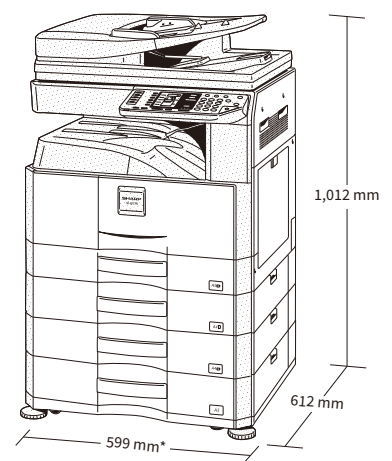

*Including adjuster.
909 mm when multi-bypass tray is extended.

Shown with options.

Distributed by:

SHARP